

2. 組立設計

2. 組立設計

ファイル保存名 : torskan

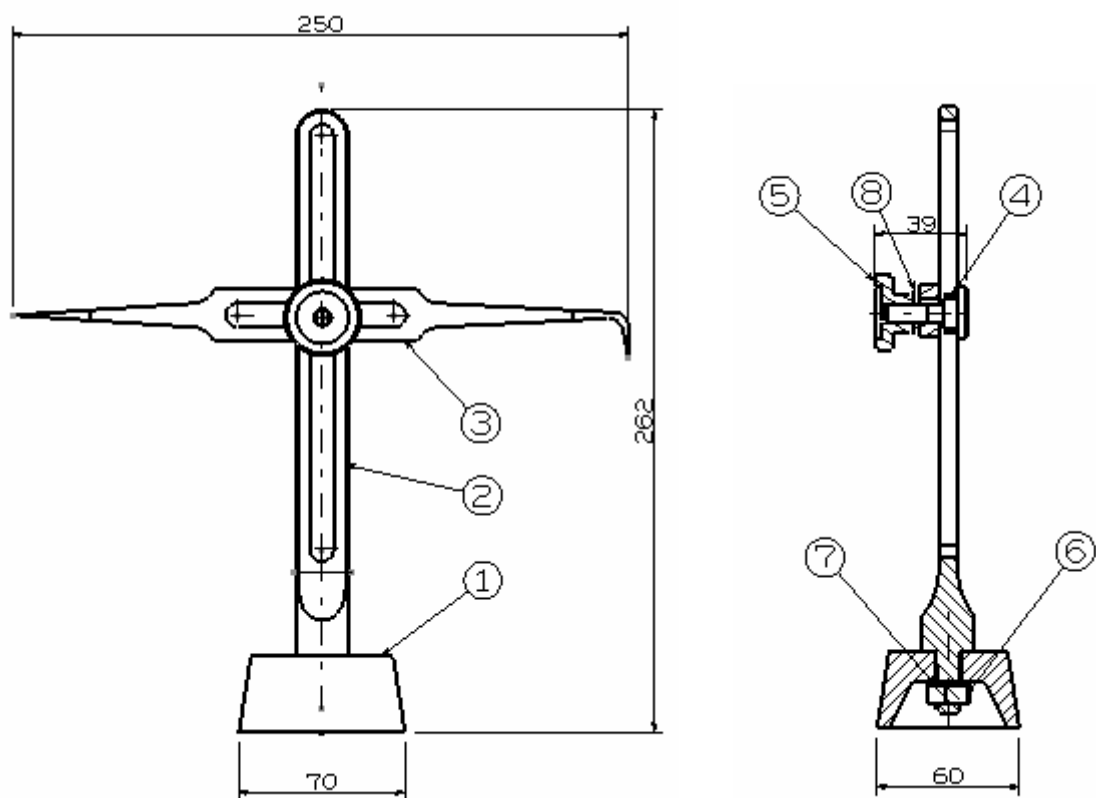

部品番号	部品名称	材料	個数	工程	重量	摘要
1	台	FC200	1	木・イ・キ・仕		
2	支柱	SS400	1	ソ・キ・仕		
3	野書き針(測定針)	SK4	1	ソ・タ・キ・仕		
4	針取付ボルト	S30C	1	ソ・キ・仕		
5	針締付ナット	SS400	1	ソ・キ・仕		
6	M10ナット		1			
7	M10座金		1			
8	ベアリング		1			

2. 組立設計

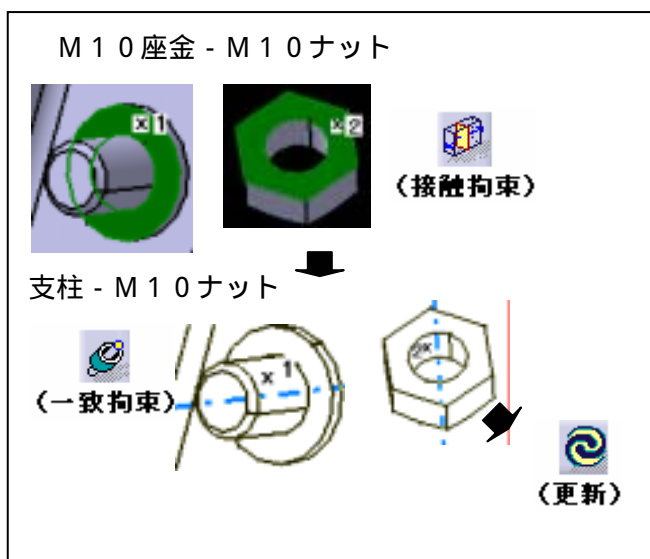
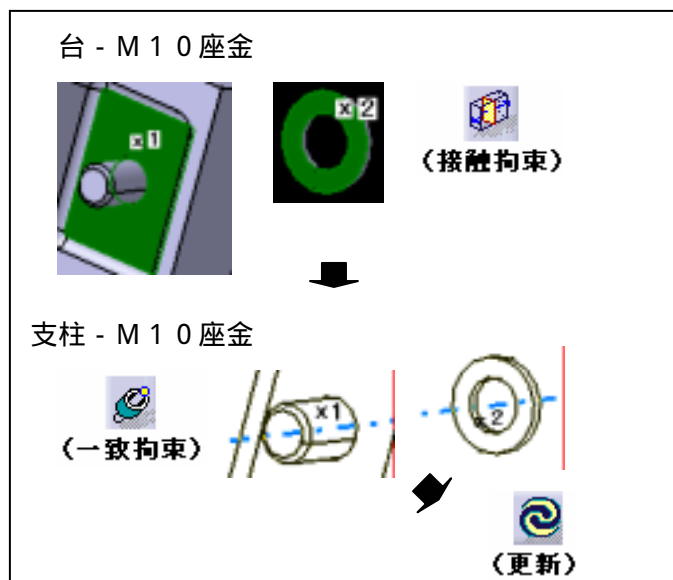
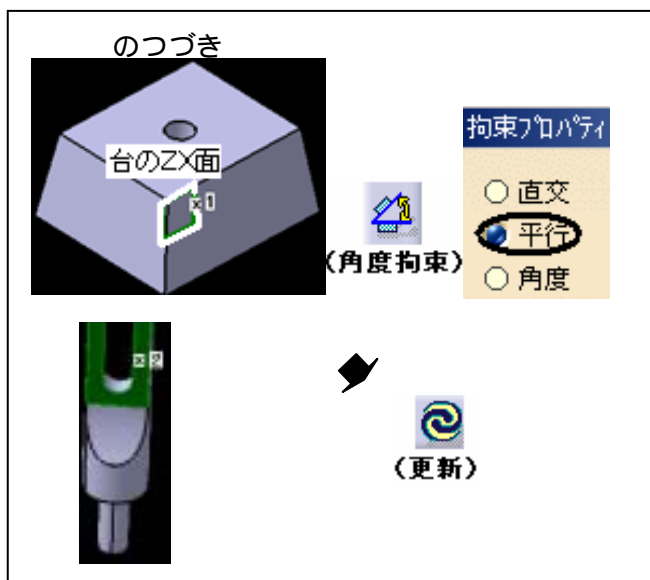
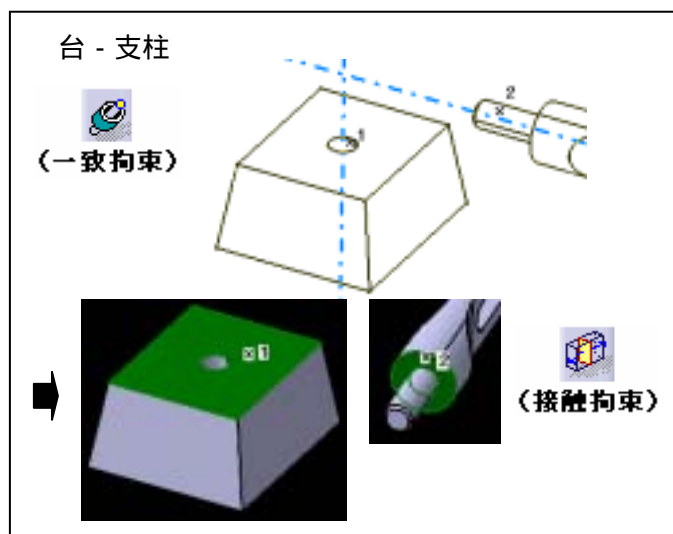
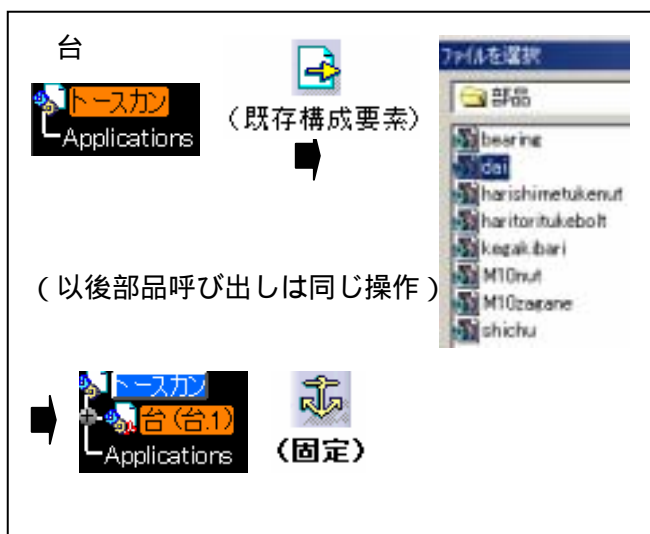

支柱 - 罫書針

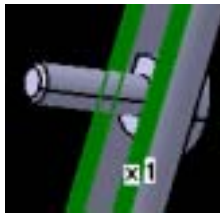

針取付ボルト - 罫書針



台 - 罫書針

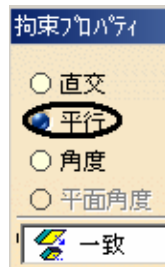
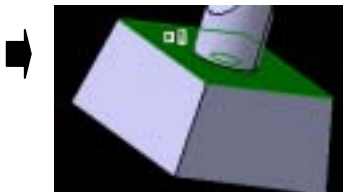

罫書針 - ベアリング

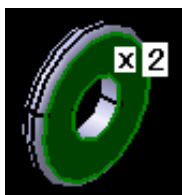

針取付ボルト - ベアリング



ベアリング - 針締付ナット

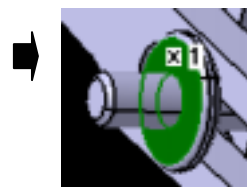

完 成

